

COILABLE HDPE CONDUIT OVALITY AND COIL-SET

TN-61

2024



Foreword

This technical note was developed and published with the technical help and financial support of the members of the Plastics Pipe Institute (PPI). These members have shown their commitment to developing and improving quality products by assisting standards development organizations in the development of standards, and also by developing design aids and reports to help engineers, code officials, specifying groups, contractors and users.

The purpose of this technical note is to provide general information about the condition of ovality and coil-set in high density polyethylene (HDPE) conduit products, and measures that can be taken by installers to reduce ovality during installation.

PPI has prepared this technical note as a service to the industry. The information in this note is offered in good faith and believed to be accurate at the time of its preparation, but is offered “as is” without any express or implied warranty, including WARRANTIES OF MERCHANTABILITY AND FITNESS FOR A PARTICULAR PURPOSE. Additional information may be needed in some areas, especially with regard to unusual or special applications. Consult the manufacturer or material supplier for more detailed information. A list of member manufacturers is available on the PPI website. PPI does not endorse the proprietary products or processes of any manufacturer and assumes no responsibility for compliance with applicable laws and regulations.

PPI intends to revise this technical note within 5 years or sooner if required, from the date of its publication, in response to comments and suggestions from users of the document. Please send suggestions of improvements via our website. Information on other publications can be obtained by contacting PPI directly or visiting our website.

For further information, contact: The Plastics Pipe Institute
105 Decker Court
Suite 825
Irving, Texas, 75062
469.499.1044
www.plasticpipe.org

This Technical Note, TN-61, was first issued in December 2019. It was revised October 11, 2024.

Table of Contents

Foreword	2
Table of Contents	3
Table of Figures	4
List of Tables	4
1.0 Scope	5
2.0 Definitions	5
2.1. Horizontal Directional Drilling (commonly referred to as HDD)	6
2.2. Stitch Boring	7
2.3. Plowing	7
3.0 Conduit Packaging Types	7
3.1. Conduit Reels	9
3.2. Straight Lengths	10
4.0 Conduit Ovality	10
4.1. Factors Influencing Ovality	10
5.0 Mitigating Ovality and Coil-set During Storage	14
6.0 Installation Techniques for minimizing ovality and coil-set.....	15
7.0 Summary	20

Table of Figures

Figure 1: HDPE conduit on steel reels	8
Figure 2: Coils of conduit on pallets	8
Figure 3: Typical steel reel for HDPE conduit.....	9
Figure 4: End of a coil of conduit showing deformation	11
Figure 5: End of a coil of conduit showing deformation	11
Figure 6: End of a coil of conduit showing deformation and ovality	11
Figure 7: Illustration of the internal forces within coiled conduit	12
Figure 8: Illustration of ovalization of conduit	12
Figure 9: Innermost layer of coiled conduit on reel.....	13
Figure 10: Example of a Straightening conduit by allowing it to lay flat.....	15
Figure 11: Example of a manual clamping/rounding tool for HDPE conduit.....	15
Figure 12: Example of a manual clamping/rounding tool for HDPE conduit.....	16
Figure 13: Friction points between cable and conduit	17
Figure 14: Device for re-rounding and straightening HDPE pipe and conduit when being dispensed from a reel or coil. This type of device is typically attached to a trailer with the pay-out reel.....	17
Figure 15: Nominal 6 inch coiled conduit being pulled through a re-rounding device....	18
Figure 16: HDPE coiled conduit passing through a re-rounding device (close-up)	18
Figure 17: HDPE coiled conduit passing through a re-rounding device (side view)	19
Figure 18: HDPE coiled conduit passing through a re-rounding device (top view).....	19

List of Tables

Table 1: Recommended Minimum Drum Diameters per NEMA TC 7-2021	14
--	----

COILABLE HDPE CONDUIT OVALITY AND COIL-SET

1.0 SCOPE

High density polyethylene (HDPE) conduit is the preferred material to house and protect electrical power and telecommunications cables within. It offers unmatched corrosion and chemical resistance, is flexible, durable and available in long reel lengths to reduce joints and installation time. HDPE conduit is available in a variety of sizes, wall types, colors, and lengths.

HDPE conduit's flexibility allows it to be coiled and provided in long lengths, thereby improving installation efficiencies. This technical note provides information about ovality caused by the coiling of HDPE conduit and cable in conduit, and methods for mitigating ovality and coil-set prior to and during installation.

2.0 DEFINITIONS

Bend Radius: the measure of conduit's curvature from a center point to the mid-line of the conduit's diameter.

Bend Angle: the measure of a conduit's change in direction, measured in degrees or radians.

Coil-Set: an inherent tendency for conduit to conform over time to the curved shape or bend radius of the coil or reel on which it has been stored.

Creep: the time dependent viscous flow component of deformation. It refers to the response of PE, over time, to a constant static load. When PE is subjected to a constant static load, it deforms immediately to a strain predicted by the stress-strain modulus determined from the tensile stress-strain curve. At high loads, the material continues to deform at an ever decreasing rate, and if the load is high enough, the material may finally yield or rupture. PE piping materials are designed in accordance with rigid industry standards to assure that, when used in accordance with industry recommended practice, the resultant deformation due to sustained loading, or creep, is too small to be of engineering concern. – [*PPI Handbook of PE Pipe, 2nd Edition*](#)

Ovality: a measurement that is expressed as a percentage of the variation between the maximum Outside Diameter (OD) minus the minimum OD, divided by the average OD.

Ovality percentage is calculated using the following formula:

$$\% \text{ Ovality} = \frac{(\text{Maximum OD} - \text{Minimum OD})}{(\text{Maximum OD} + \text{Minimum OD})} \times 200$$

Ovality is specified in product standards and is measured at the time of manufacture in accordance with industry standards.

Pipe Stiffness (PS): the value obtained by dividing the force per unit length of specimen by the resulting deflection in the same units at the prescribed percentage deflection.ⁱ

Wall Thickness: the actual thickness of the conduit wall, measured as half of the difference between the outside diameter and the inside diameter at any point along the conduit wall. HDPE conduit is available in several diameter types (e.g. IPS, SIDR, True-size, and Schedule) and several wall types (e.g. SDR, SIDR, and Schedule). Definitions of each of those wall types are published in *ASTM F412 Standard Terminology Related to Plastic Piping Systems* and copied below with permission of ASTM International.

Standard dimension ratios (SDR): a specific ratio of the average specified outside diameter to the minimum specified wall thickness (D_o/t) for outside diameter-controlled plastic pipe, the value of which is derived by adding one to the pertinent number selected from the ANSI Preferred Number Series 10.ⁱⁱ

Standard inside diameter dimension ratio (SIDR): a specific ratio of the average specified inside diameter to the minimum specified wall thickness (D_i/t) for inside diameter controlled plastic pipe, the value of which is derived by subtracting one from the pertinent number selected from the ANSI Preferred Number Series 10.ⁱⁱ

Schedule: a pipe size system (outside diameters and wall thicknesses) originated by the iron pipe industry.

See industry standards such as ASTM F2160ⁱⁱⁱ, NEMA TC 7^{iv}, CSA C22.2 No.327^v, or UL 651A^{vi} for actual conduit dimensions, and ASTM D3485^{vii} or UL 1990^{viii} for cable in conduit dimensions.

Stress relaxation: another unique property arising from the viscoelastic nature of PE. When subjected to a constant strain (deformation of a specific degree) that is maintained over time, the load or stress generated by the deformation slowly decreases over time, but it never relaxes completely. This stress relaxation response to loading is of considerable importance to the design of PE piping systems. It is a response that decreases the stress in pipe sections which are subject to constant strain. – [PPI Handbook of PE Pipe, 2nd Edition](#)

Trade size: nominal diameter

Trenchless Installations: Methods of installing conduit that does not require digging a trench for installation of the conduit. Trenchless methods include:

2.1. Horizontal Directional Drilling (commonly referred to as HDD)

A technique for installing pipes, such as conduit, below ground using a surface-mounted drill rig that launches and places a drill string at a shallow angle to the surface and has tracking and steering capabilities.

2.2. Stitch Boring

A technique whereby a series of small pits are dug, and a pneumatically-driven earth piercing tool is used to bore a hole from pit to pit, creating a hole into which the conduit can be pulled.

2.3. Plowing

A technique whereby a plow is inserted and dragged through the ground, creating a furrow into which the conduit will be installed. Two sub-types of plowing exist:

- Chute Plowing: conduit is fed through a chute trailing the plow into the bottom of the furrow created in the ground
- Pull Plowing: conduit is pulled into the furrow from a pit as the plow is being pulled through the ground.

Re-rounding: The action of physically correcting ovality by the use of either clamping tools or equipment that applies mechanical pressure to re-round the conduit.

Solar-wrap: A protective film that may be used to cover conduit on reels or coils and will reflect or absorb solar radiation.

Viscoelasticity: Due to its molecular nature, PE is a complex combination of elastic-like and fluid-like (viscous) elements. As a result, PE displays properties that are intermediate to crystalline metals and very high viscosity fluids. – [PPI Handbook of PE Pipe, 2nd Edition](#).

3.0 CONDUIT PACKAGING TYPES

Some of the key advantages of using HDPE conduit are its ductility and flexibility. These two properties allow nominal sizes from ½ to 6 inch to be wound onto reels (See **Figure 1**) or simply as coils in long continuous lengths, often shipped on pallets (See **Figure 2**). Long continuous lengths of HDPE conduit minimize joining and are ideally suited for installation underground either laid into an open trench and backfilled, or using trenchless installation techniques.

See [PPI TN-58 Guide to Handling HDPE Conduit & Duct](#) for information on handling reels and coils.



Figure 1: HDPE conduit on steel reels



Figure 2: Coils of conduit on pallets

3.1. Conduit Reels

Coiling HDPE conduit on reels is the most commonly used packaging option for conduit in nominal diameters of 6 inch or less. Installers typically use reel handling equipment for transporting cables to be field-installed into the conduit. Typically, the same equipment can be used for deploying reeled conduit.

3.1.1. Reel Design and Components:

The reel flange (F) forms the overall diameter and the drum, or hub, (D) is created by the spacing of the staves that also connect two or more flanges together. Normally, the overall width (W) of reels is between 48 to 50 inches, so that two reels can be shipped side by side and remain within the overall width of the truck bed on which they will be transported. The arbor holes (A) are typically a standard diameter of approximately 3.75 inches to fit the standard bars. See **Figure 3**.

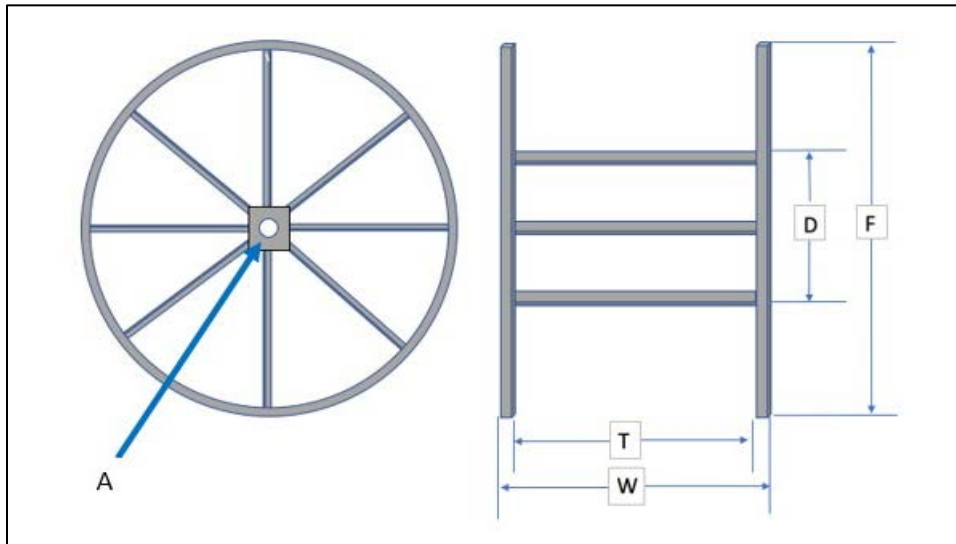

Figure 3: Typical steel reel for HDPE conduit

where:

- F* = Flange diameter
- D* = Drum or hub diameter
- T* = Traverse
- W* = Width
- A* = Arbor hole diameter

3.2. Straight Lengths

A third packaging option less frequently used is straight lengths, sometimes called “sticks”, sometimes used for nominal diameters of 3 inch and larger. HDPE conduit straight lengths are typically available in lengths up to 50 feet (15.2 m). Sticks are often used for diameters larger than nominal 6 inch, simply because those diameters are generally too large to coil and be transportable in conventional trucks.

4.0 CONDUIT OVALITY

HDPE conduit is initially manufactured with minimal ovality, typically less than 3%. Due to its flexible nature, HDPE conduit will become more oval or out-of-round when it is wound onto reels or coils. This is permitted within industry standards. Once uncoiled, the conduit may not recover all its original extruded round shape so re-rounding may be required.

For example, ASTM F2160 *Standard Specification for Solid Wall High Density Polyethylene (HDPE) Conduit Based on Controlled Outside Diameter (OD)* lists the following requirements about the allowable percentages of ovality by size:^{ix}

- 5.2.7 Ovality - “The ovality (cross section) of 2 inch IPS and smaller conduit shall not exceed 7% when measured in accordance with [section] 6.4. Coiled conduit larger than 2 inch IPS through 3 inch. IPS shall not exceed 10% when measured in accordance with 6.4. Kinks in a coil shall not be acceptable.”
- 5.2.7.2 “If ovality greater than 10% for coiled conduit larger than 3 inch IPS is unsuitable for a particular application, the coiled conduit shall be processed by the installer through re-rounding equipment that corrects ovality to 10% or less.”

4.1. Factors Influencing Ovality

The amount of ovality in conduit that results from coiling can vary, based on several factors. The primary factor is the diameter of the conduit, while the secondary factor is the bend radius of the coiled conduit.

Other factors which influence the percentage and permanence of the ovality are:

- Pipe stiffness
- Wall thickness
- Creep resistance
- Time stored in the coiled configuration
- Ambient temperature and temperature cycles while in storage

Depending on the methods used for tying or wrapping conduit in reels or coils, the beginning and end of each coil, possibly several feet in length, should be cut off and discarded as it is likely to have been deformed when the ends of the coil were secured. See **Figures 4, 5 and 6**.



Figure 4: End of a coil of conduit showing deformation



Figure 5: End of a coil of conduit showing deformation



Figure 6: End of a coil of conduit showing deformation and ovality

As PE conduit is coiled, the outer portion of the diameter of each wrapped layer is in tension, and the inner portion of the diameter is in compression (See **Figure 7**).

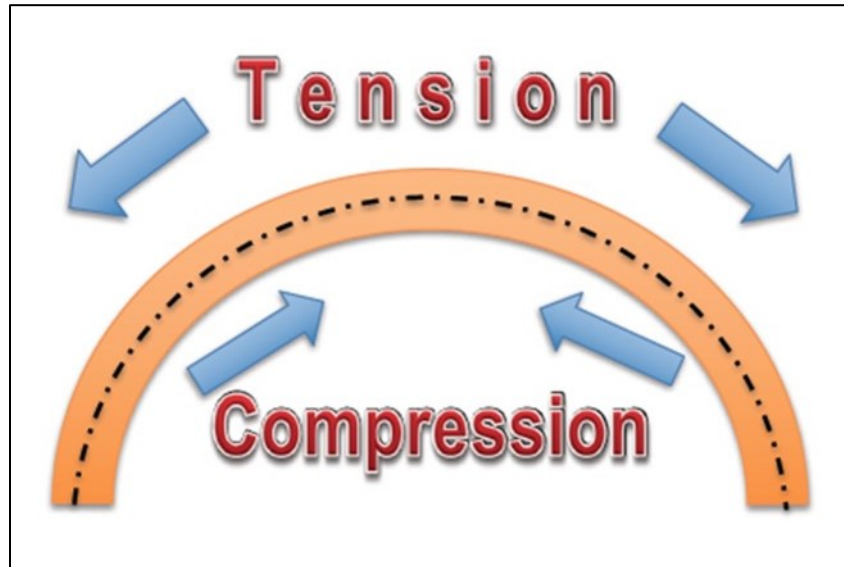

Figure 7: Illustration of the internal forces within coiled conduit

The resulting stress caused by these two opposing forces, with the outer radius of the conduit in tension and the inner radius in compression, forces conduit to compensate by flattening, causing it to expand or ovalize at its center line (see **Figure 8**).

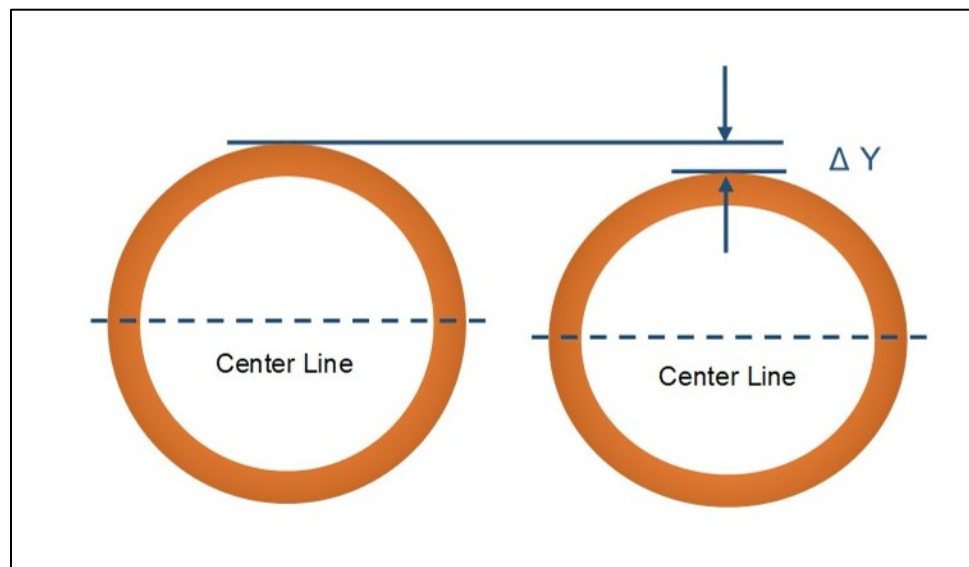

Figure 8: Illustration of ovalization of conduit

As a conduit's diameter increases for the same radius of curvature, the amount of stress along the center line of the conduit increases, causing greater ovalization (expansion of the radius) at the center line in order to compensate. The ovalization can be shown in **Figure 8** as the ΔY distance.

As a conduit's diameter increases, the distance from its outer surface to the center line also increases. This greater distance from the conduit's center line to the outer radius, for the same bend radius, results in greater opposing outer radius tensile and inner radius compressive stress. This results in greater ovality for larger diameter products.

The most pronounced ovality occurs at the innermost coiled layer, because this is the location where the radius of curvature of the coil or reel is the smallest. See **Figure 9**. For example, the inner coil layers of nominal 6 inch IPS coiled conduit may have ovality of 20% or more when initially removed from the reel.

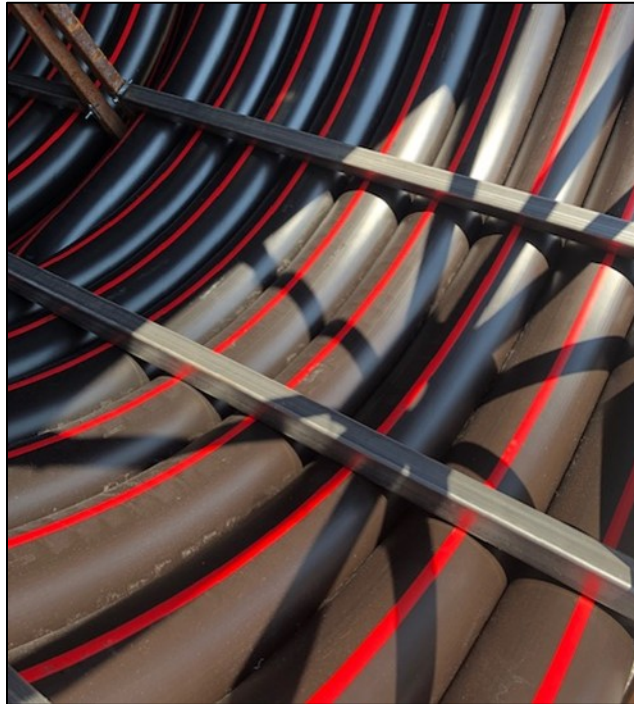

Figure 9: Innermost layer of coiled conduit on reel

Ovality becomes progressively less pronounced for each successive wrapped layer because the radius of curvature gets larger. To help minimize ovality caused by packaging, graduated reel/coil drum diameters are recommended for each conduit diameter.

Drum diameters for coiled conduit are recommended to be a minimum of 18 times the conduit's actual outside diameter.

Table 1 shows recommended drum diameters for SDR, SIDR, True-size and Schedule wall-type conduit sizes, as per *NEMA TC 7 Standard for High Density Polyethylene (HDPE) Raceway Conduit* available at www.NEMA.org.

Table 1: Recommended Minimum Drum Diameters per NEMA TC 7-2021

Trade Size	Metric Trade Size	Drum Diameter	
		inch	cm
1/2	13	18	48
3/4	19	18	48
1	25	24	61
1 1/4	32	30	76
1 1/2	38	30	76
2	51	36	92
2 1/2	64	42	107
3	76	48	122
4	102	68	173
5	127	84	214
6	152	84	214

Note 1: The minimum drum diameter is approximately 18 times the average conduit actual outside diameter, rounded up or down to the nearest integer. Depending on the conduit dimensional type (e.g. IPS, SIDR, True-size, or Schedule) the actual outside diameter varies, and is never exactly the same as the nominal diameter (i.e. trade size). See industry standards such as ASTM F2160, ASTM D3485, NEMA TC 7, UL 651A, UL 1990, or CSA C22.2 No.327 for actual conduit dimensions.

Note 2: Due to shipping height limitations, the maximum reel or coil flange diameter commercially available is typically 120 inches (3.04 m). For this reason, it may be necessary to use a smaller drum size than would be indicated by 18x diameter when coiling nominal diameters 4, 5 and 6 inch conduit; this packaging requirement may result in increased ovality for these three diameters of coilable conduit.

The percentage of roundness that will be recoverable when unreeling coiled conduit depends upon the amount of time it has been under stress, as well as other factors listed in Section 4.1. Over time, coiled conduit will strain relieve, resulting in the ovality permanently setting, a condition also known as coil-set.

5.0 MITIGATING OVALITY AND COIL-SET DURING STORAGE

Coilable conduit is typically stored outdoors, uncovered and exposed to sunlight and the elements. Under these conditions, the coiled conduit will be exposed to cycles of changes in temperature daily. Both time and temperature cycling will contribute to reorienting the molecular structure, setting the new memory of ovality and coil-set. For these reasons, it is strongly recommended that the oldest material in stock be used first, in order to help minimize the time the conduit is stored under the stress of being coiled. A first in - first out (FIFO) inventory rotation procedure is recommended.

Another option for outside storage is to place a *solar wrap* around the conduit, since covering coiled conduit with a protective material will help to shield it from both possible UV degradation and reduce exposure to temperature changes.

For anticipated longer periods of storage, and when space permits, storing the conduit indoors or under a shelter and out of direct sunlight will help to slow down the rate of

these changes. For example, storing conduit in a warehouse, where variations in temperature are typically less extreme, can help slow down any unwanted changes.

6.0 INSTALLATION TECHNIQUES FOR MINIMIZING OVALITY AND COIL-SET

If there is space to lay out the conduit next to a trench prior to installation, this step will help the conduit to stress relieve, allowing it to recover some of its roundness and straightness. This technique can be especially effective on a warm or sunny day, as the stress relief happens faster at higher temperatures. See **Figure 10**.



Figure 10: Example of a Straightening conduit by allowing it to lay flat

When joining HDPE conduit using a mechanical coupling, it may be helpful to use a tool for rounding the end of the conduit prior to installing the coupler. In nominal sizes larger than 3 to 6 inch, where the ovality might be greater, using a clamp-type rounding tool can be very helpful for installing the coupler. See **Figures 11** and **12**.



Figure 11: Example of a manual clamping/rounding tool for HDPE conduit

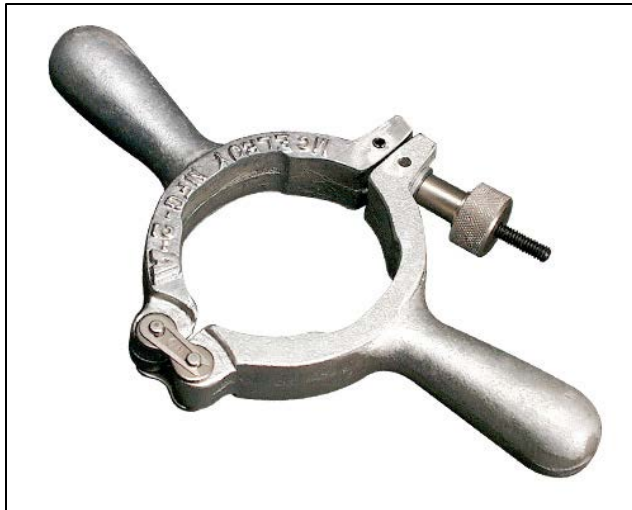

Figure 12: Example of a manual clamping/rounding tool for HDPE conduit

As the ambient temperature drops below 45°F (7°C), the conduit's stiffness will increase, making it less flexible and more difficult to control. In cooler temperatures, any coil-set or ovality that has been introduced during storage may require more mechanical force in order to be removed. Preheating the conduit can help, possibly by storing the reel in a warm warehouse, or by blowing warm air through it.

Note 3: Open flame heaters are not recommended for warming.

Also, adding some tension to the conduit, possibly by using a reel brake as it is being pulled off the bottom of the reel into the trench, will help remove unwanted undulations so that the conduit will lay straighter in the trench.

These techniques are more critical when placing the conduit in a trench, where it has more freedom of movement.

Minimizing the number of directional changes (i.e. curvature) during conduit installation is important. This is because directional changes increase the number of friction points, increasing the resultant tensile load placed on a cable during installation. See **Figure 13**.

Note 4: See [PPI TN-48 Guidelines for Choosing Wall Thickness for HDPE Conduit Based On "Mini-HDD" \(Horizontal Directional Drilling\): Using the PPI Conduit Design Calculator](#) and [PPI MAB-7 Guidelines for use of Mini-Horizontal Directional Drilling for Placement of HDPE \(PE4710\) Pipe in Municipal Applications](#) for more information about planned and unplanned curvature that can occur during horizontal directional drilling installations.

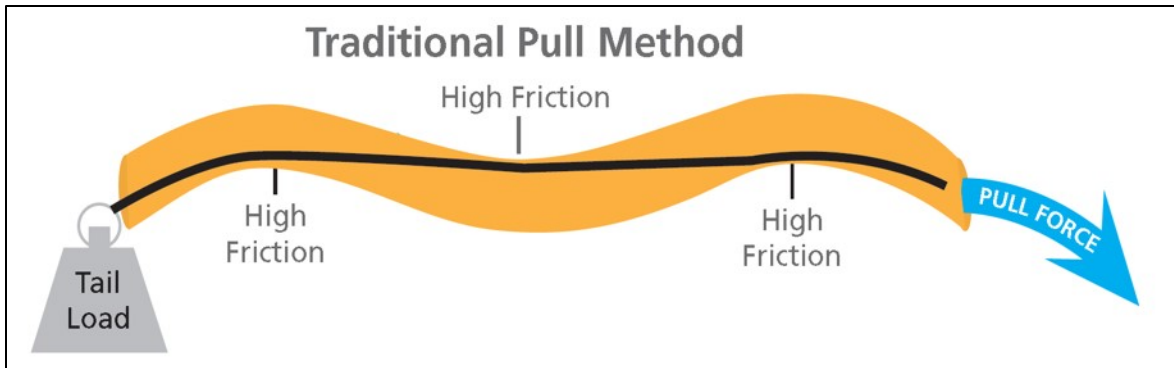

Figure 13: Friction points between cable and conduit as the result of directional changes/curvature in the conduit

Reducing directional changes allows cables to be pulled over longer distances without exceeding their allowable working tensile strength.

Coil-set tends to be less of a concern when placing coilable conduit in trenchless installations. This is because during these installation methods, the conduit is generally under tension. But if ovality is a pre-existing condition, then it could be worsened when using a trenchless installation method. For this reason, it would be best to pull the conduit through a rounding and straightening device.

Ovality is corrected when joining equipment is applied to roundable conduit, or by field-processing roundable conduit through the use of re-rounding and straightening equipment during installation. See **Figure 14**.

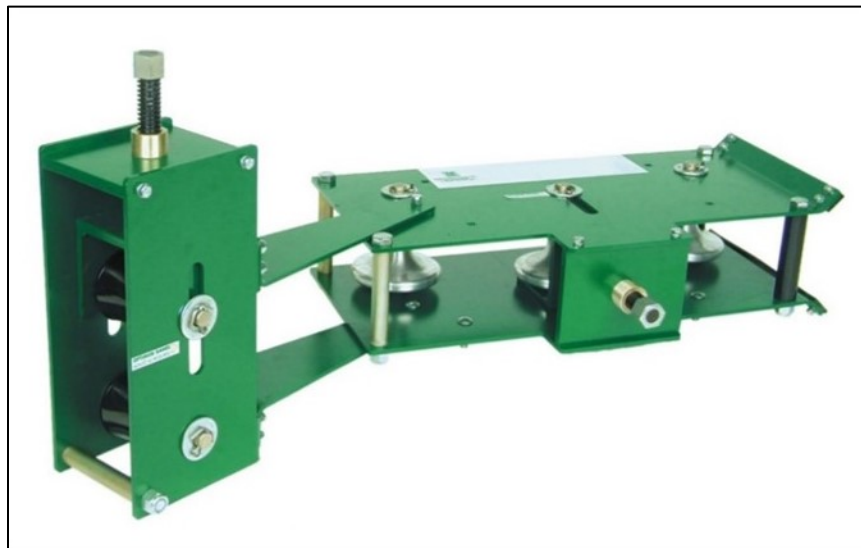

Figure 14: Device for re-rounding and straightening HDPE pipe and conduit when being dispensed from a reel or coil. This type of device is typically attached to a trailer with the pay-out reel

A re-rounding device mechanically rounds and straightens conduit by pulling it through a series of rollers that can be adjusted for the diameter conduit that is being installed. Controls on the re-rounding device are adjusted to allow for the amount of rounding and straightening pressure to be applied, based on the conduit wall thickness and the ambient temperature. Always follow the manufacturer's instructions.

Re-rounding devices are available as trailer-mounted systems for deploying coils or reels of conduit. **Figures 15, 16, 17, and 18** show trailer-mounted coil deployment systems with conduit being rounded and straightened prior to being placed in a trench.



Figure 15: Nominal 6 inch coiled conduit being pulled through a re-rounding device



Figure 16: HDPE coiled conduit passing through a re-rounding device (close-up)

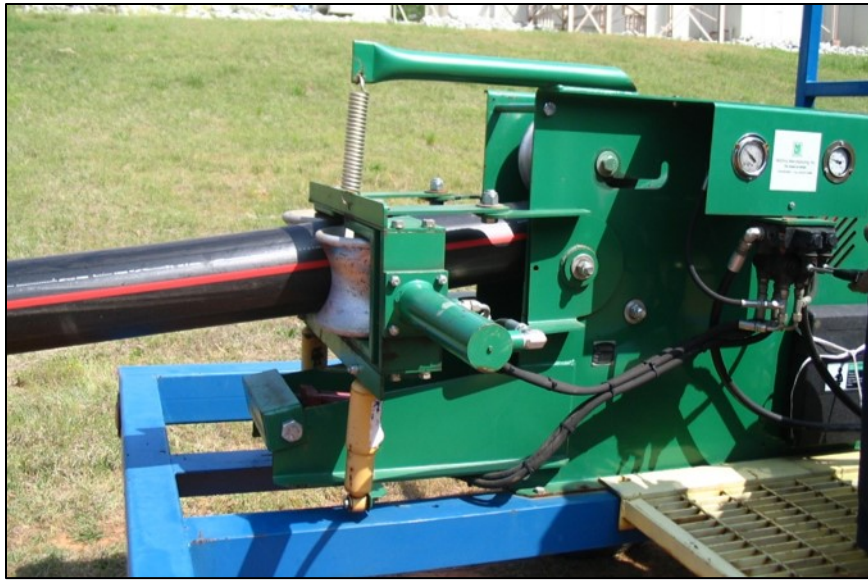

Figure 17: HDPE coiled conduit passing through a re-rounding device (side view)

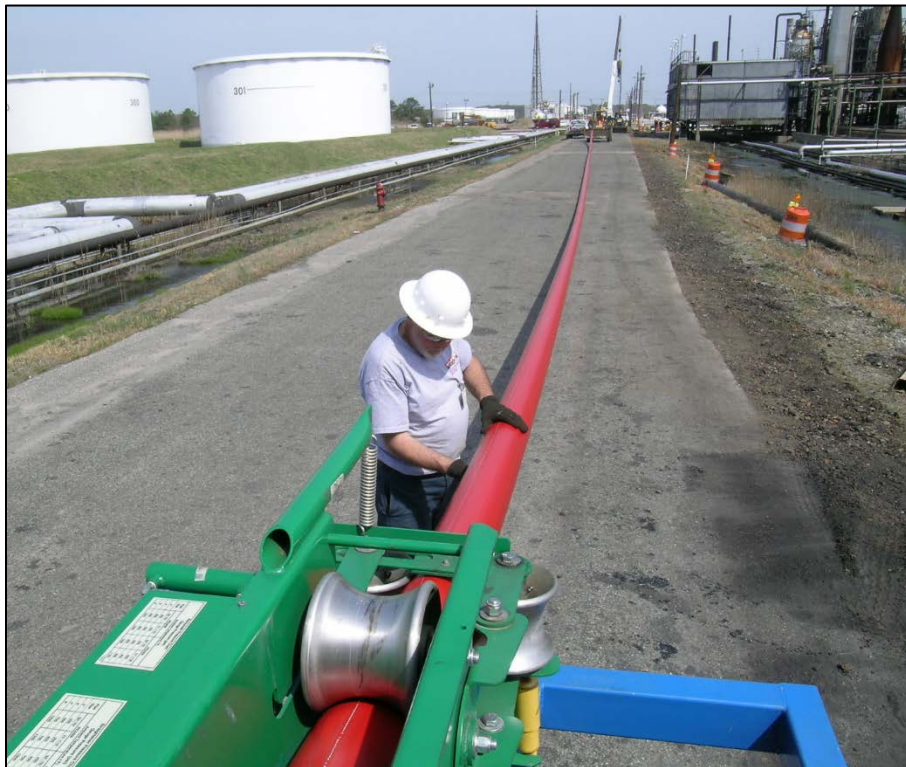

Figure 18: HDPE coiled conduit passing through a re-rounding device (top view)

7.0 SUMMARY

The flexibility of high density polyethylene (HDPE) conduit allows most diameters to be coiled for winding onto reels or into coils for transportation in long continuous lengths. This greatly improves the speed and efficiency of field installations.

This technical note provides information about ovality caused by the coiling of HDPE conduit and cable in conduit, and methods for mitigating ovality and coil-set prior to and during installation.

The coiling of HDPE conduit produces stress throughout the pipe wall, resulting in ovality; the extent of ovality is initially dependent on the radius of curvature and outside diameter of the conduit. Coiling will also result in varying degrees of coil-set over time. The magnitude of both ovality and coil-set are dependent on wall thickness of the conduit, radius of curvature, time under stress, temperature-cycling, and the conduit diameter vs. radius of curvature.

Ovality may be more pronounced in larger diameters and coil-set can occur more rapidly, especially if there are large fluctuations in temperature during storage. This is recognized and permitted in product industry standards.

There are methods for mitigation of ovality and coil-set, and several re-rounding techniques are available to correct problems when they occur. These techniques have proven successful over many years and thousands of installations, resulting in positive results when using HDPE conduit.

ⁱ Extracted, with permission, from ASTM D2412 *Standard Test Method for Determination of External Loading Characteristics of Plastic Pipe by Parallel-Plate Loading*, ASTM International, USA. www.astm.org

ⁱⁱ Extracted, with permission, from ASTM F412 *Standard Terminology Related to Plastic Piping Systems*, ASTM International, USA. www.astm.org

ⁱⁱⁱ ASTM F2160 *Standard Specification for Solid Wall High Density Polyethylene (HDPE) Conduit Based on Controlled Outside Diameter (OD)*, ASTM International, USA. www.astm.org

^{iv} NEMA TC-7, *Solid-Wall Coilable and Straight Electrical Polyethylene Conduit*, National Electrical Manufacturers Association, USA.

^v CSA C22.2. No. 327, *HDPE Conduit, Conductors-in-Conduit, and fittings*, CSA Group, Canada.

^{vi} UL 651A, *High Density Polyethylene (HDPE) Conduit*, ULSE Inc., USA.

^{vii} ASTM D3485, *Standard Specification for Coilable High Density Polyethylene (HDPE) Cable in Conduit (CIC)*, ASTM International, USA. www.astm.org

^{viii} UL 1990, *Nonmetallic Underground HDPE Conduit with Conductors*, ULSE Inc., USA.

^{ix} Extracted, with permission, from ASTM F2160 *Standard Specification for Solid Wall High Density Polyethylene (HDPE) Conduit Based on Controlled Outside Diameter (OD)*, copyright ASTM International, ASTM International, USA. www.astm.org